

# ML200SE Series

## 2W, Single Output Ultra-Miniature SMT DC/DC Converters



### Key Features:

- 2W Output Power
- Ultra-Miniature SMT Case
- High Efficiency
- 1,500 VDC Isolation
- Single Output
- -40°C to +105°C Operation
- >3.5 MHour MTBF
- 17 Standard Models
- Tape & Reel Available
- **LOW COST!**



MicroPower Direct



### Electrical Specifications

Specifications typical @ +25°C, nominal input voltage & rated output current, unless otherwise noted. Specifications subject to change without notice.

#### Input

| Parameter           | Conditions   | Min. | Typ. | Max. | Units |
|---------------------|--------------|------|------|------|-------|
| Input Voltage Range | 5 VDC Input  | 4.5  | 5.0  | 5.5  | VDC   |
|                     | 12 VDC Input | 10.8 | 12.0 | 13.2 |       |
|                     | 15 VDC Input | 13.5 | 15.0 | 16.5 |       |
|                     | 24 VDC Input | 21.6 | 24.0 | 26.4 |       |
| Input Filter        | Capacitor    |      |      |      |       |

#### Output

| Parameter                           | Conditions                | Min. | Typ. | Max.  | Units    |
|-------------------------------------|---------------------------|------|------|-------|----------|
| Output Voltage Accuracy             |                           |      | ±3.0 |       | %        |
| Capacitive Load                     |                           |      |      | 220   | µF       |
| Line Regulation                     | 3.3 VOUT Models           |      |      | ±1.5  | %/%      |
|                                     | All Other Models          |      |      | ±1.2  |          |
| Load Regulation, See Note 1         | See Model Selection Guide |      |      |       |          |
| Ripple & Noise (20 MHz), See Note 2 | 24V Output Models         |      | 100  | 200   | mV P - P |
|                                     | All Other Models          |      | 100  | 150   |          |
| Temperature Coefficient             |                           |      |      | ±0.03 | %/°C     |
| Output Short Circuit, See Note 3    | Momentary (1S Max)        |      |      |       |          |

#### General

| Parameter             | Conditions    | Min.  | Typ. | Max. | Units |
|-----------------------|---------------|-------|------|------|-------|
| Isolation Voltage     | 60 Seconds    | 1,500 |      |      | VDC   |
| Isolation Resistance  | 500 VDC       | 1,000 |      |      | MΩ    |
| Isolation Capacitance | 100 kHz, 0.1V |       | 20   |      | pF    |
| Switching Frequency   |               |       | 100  | 300  | kHz   |

#### EMI Characteristics

| Parameter           | Standard     | Criteria | Level        |
|---------------------|--------------|----------|--------------|
| Radiated Emissions  | EN 55032     |          | B            |
| Conducted Emissions | EN 55032     |          | B            |
| ESD                 | EN 61000-4-2 | B        | ±8kV Contact |

#### Environmental

| Parameter                   | Conditions          | Min. | Typ. | Max. | Units |
|-----------------------------|---------------------|------|------|------|-------|
| Operating Temperature Range | Ambient             | -40  | +25  | +105 | °C    |
| Storage Temperature Range   |                     | -55  |      | +125 | °C    |
| Cooling                     | Free Air Convection |      |      |      |       |
| Humidity                    | RH, Non-condensing  |      |      | 95   | %     |

#### Physical

|               |  |  |  |  |  |
|---------------|--|--|--|--|--|
| Case Size     | See Mechanical Drawing (Page 4)        |  |  |  |  |
| Case Material | Non-Conductive Black Plastic (UL94-V0) |  |  |  |  |
| Weight        | 0.05 Oz (1.52g)                        |  |  |  |  |

#### Reliability Specifications

| Parameter | Conditions                      | Min. | Typ. | Max. | Units  |
|-----------|---------------------------------|------|------|------|--------|
| MTBF      | MIL HDBK 217F, 25°C, Gnd Benign | 3.5  |      |      | MHours |

#### Absolute Maximum Ratings

| Parameter                   | Conditions                  | Min. | Typ. | Max. | Units |
|-----------------------------|-----------------------------|------|------|------|-------|
| Input Voltage Surge (1 Sec) | 5 VDC Input                 |      |      | 9.0  | VDC   |
|                             | 12 VDC Input                |      |      | 18.0 |       |
|                             | 15 VDC Input                |      |      | 21.0 |       |
|                             | 24 VDC Input                |      |      | 30.0 |       |
| Peak Reflow Temperature     | See Note 4                  |      |      | 245  | °C    |
| Lead Temperature            | 1.5 mm From Case For 10 Sec |      |      | 300  | °C    |

**Caution:** Exceeding Absolute Maximum Ratings may damage the module. These are not continuous operating ratings.

# Model Selection Guide

| Model Number | Input         |             |              |         | Output        |                   |                   | Load Regulation | Efficiency (% Typ) | Fuse Rating Slow-Blow (mA) |
|--------------|---------------|-------------|--------------|---------|---------------|-------------------|-------------------|-----------------|--------------------|----------------------------|
|              | Voltage (VDC) |             | Current (mA) |         | Voltage (VDC) | Current (mA, Max) | Current (mA, Min) |                 |                    |                            |
|              | Nominal       | Range       | Full-Load    | No-Load |               |                   |                   |                 |                    |                            |
| ML205S-03E   | 5             | 4.50 - 5.50 | 366          | 30      | 3.3           | 400.0             | 40.0              | 18.0            | 72                 | 1,000                      |
| ML205S-05E   | 5             | 4.50 - 5.50 | 506          | 30      | 5.0           | 400.0             | 40.0              | 12.0            | 79                 | 1,000                      |
| ML205S-09E   | 5             | 4.50 - 5.50 | 489          | 30      | 9.0           | 222.0             | 22.0              | 9.0             | 82                 | 1,000                      |
| ML205S-12E   | 5             | 4.50 - 5.50 | 489          | 30      | 12.0          | 167.0             | 17.0              | 8.0             | 82                 | 1,000                      |
| ML205S-15E   | 5             | 4.50 - 5.5  | 482          | 30      | 15.0          | 133.0             | 13.0              | 7.0             | 83                 | 1,000                      |
| ML212S-05E   | 12            | 10.8 - 13.2 | 211          | 25      | 5.0           | 400.0             | 40.0              | 12.0            | 79                 | 500                        |
| ML212S-09E   | 12            | 10.8 - 13.2 | 203          | 25      | 9.0           | 222.0             | 22.0              | 9.0             | 82                 | 500                        |
| ML212S-12E   | 12            | 10.8 - 13.2 | 203          | 25      | 12.0          | 167.0             | 17.0              | 8.0             | 82                 | 500                        |
| ML212S-15E   | 12            | 10.8 - 13.2 | 201          | 25      | 15.0          | 133.0             | 13.0              | 7.0             | 83                 | 500                        |
| ML212S-24E   | 12            | 10.8 - 13.2 | 198          | 25      | 24.0          | 83.0              | 8.0               | 6.0             | 84                 | 500                        |
| ML215S-05E   | 15            | 13.5 - 16.5 | 169          | 18      | 5.0           | 400.0             | 40.0              | 12.0            | 79                 | 400                        |
| ML215S-15E   | 15            | 13.5 - 16.5 | 160          | 18      | 15.0          | 133.0             | 13.0              | 7.0             | 83                 | 400                        |
| ML224S-05E   | 24            | 21.6 - 26.4 | 105          | 15      | 5.0           | 400.0             | 40.0              | 12.0            | 79                 | 250                        |
| ML224S-09E   | 24            | 21.6 - 26.4 | 102          | 15      | 9.0           | 222.0             | 22.0              | 9.0             | 82                 | 250                        |
| ML224S-12E   | 24            | 21.6 - 26.4 | 102          | 15      | 12.0          | 167.0             | 17.0              | 8.0             | 82                 | 250                        |
| ML224S-15E   | 24            | 21.6 - 26.4 | 100          | 15      | 15.0          | 133.0             | 13.0              | 7.0             | 83                 | 250                        |
| ML224S-24E   | 24            | 21.6 - 26.4 | 99           | 15      | 24.0          | 83.0              | 8.0               | 6.0             | 84                 | 250                        |

**Notes:**

1. Output load regulation is specified for a load change of 10% to 100%.
2. When measuring output ripple, it is recommended that a 1  $\mu$ F capacitor and a 10  $\mu$ F capacitor be placed in parallel from the +Vout pin to the -Vout pin.
3. Units must be restarted after a short circuit fault.
4. The recommended reflow settings are given below.
5. It is recommended that the minimum output load should be at least 10%. Continuous operation below this level could damage the unit.
6. These converters are specified for operation without external components. However, in some applications the addition of input/output capacitors will enhance stability and reduce output ripple. The simple connection shown on page 3 will typically meet EN 55022 Class B.
7. The model ML215S-05E has not been tested to CE standards.
8. It is recommended that a fuse be used on the input of a power supply for protection. See the Model Selection table above for the correct rating.

## Derating Curve

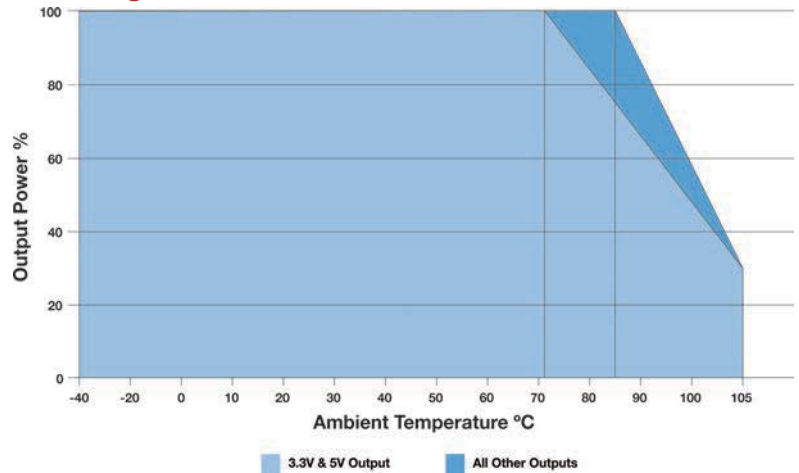

## Reflow Solder Settings

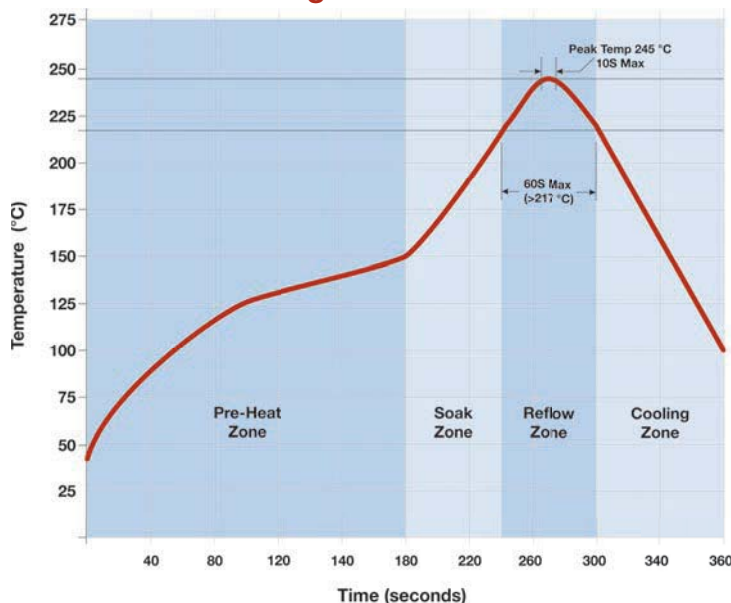

The **ML200SE** series is designed to meet the IPC/JEDEC standard J-STD-020D.1 for reflow soldering. The recommended reflow settings are a peak temperature of 245 °C for a maximum period (TPK) of 10S and a time above liquidous (TL) of  $\leq 60$  seconds at 217 °C, as illustrated at left.

For more information, please contact the factory.

## Simple Connection

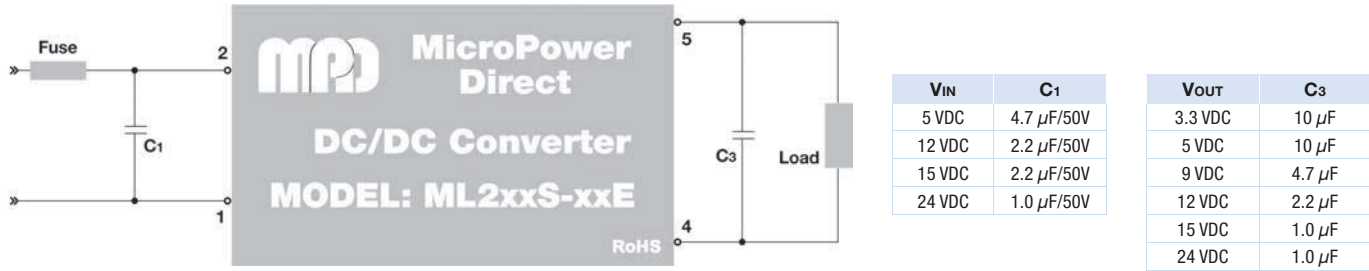

The diagram above illustrates a simple connection of the ML200SE series. For applications that do not require the circuit to meet EMI/EMC specifications, the capacitors C1, and C3 will reduce input/output ripple and improve the converter stability over time and temperature. The recommended component values are given in the table at right.

## Typical Connection

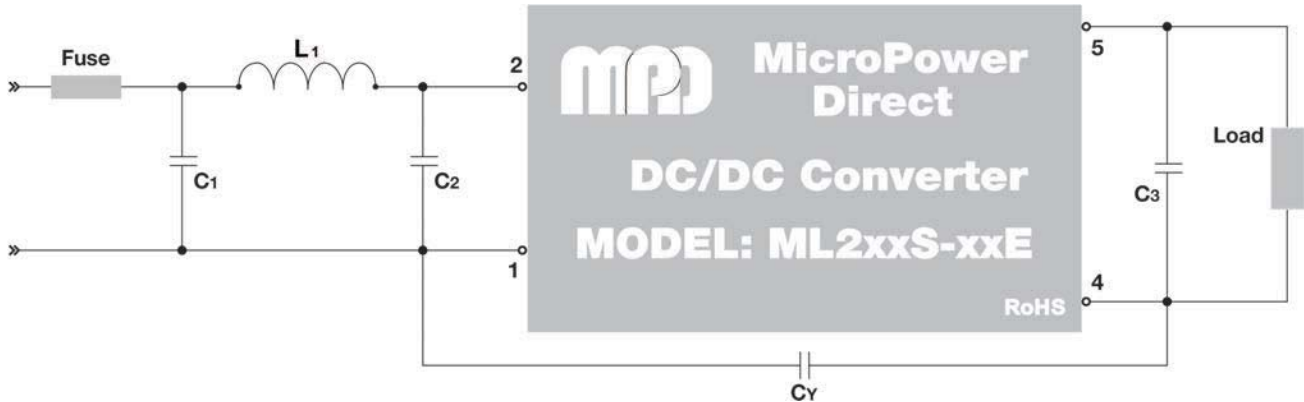

The diagram above illustrates a typical connection of the ML200SE series for an application that requires compliance to EMI/EMC standards EN 55032 and EN 61000-4 (as specified on page 1). Some notes on these components are:

1. An external fuse is recommended to protect the unit in the event of a fault on the input line. A recommended value is given in model selection table on page 2.
2. The output filtering capacitor (C3) is a high frequency, low resistance electrolytic capacitor. Care must be taken in choosing this capacitor not to exceed the capacitive load specification

for the unit. Voltage derating of capacitors should be 80% or above.

3. Suggested component values are:

| Component | V <sub>IN</sub> : 5V, 12V, 15V | V <sub>IN</sub> : 24V |
|-----------|--------------------------------|-----------------------|
| C1        | 4.7 $\mu$ F/50V                | 4.7 $\mu$ F/50V       |
| C2        | 4.7 $\mu$ F/50V                | 4.7 $\mu$ F/50V       |
| L1        | 6.8 $\mu$ H                    | 6.8 $\mu$ H           |
| C3        | See C3 in Table Above          |                       |
| CY        | ---                            | 1 nF/2 kV             |

4. In many applications, simply adding input/output capacitors will enhance the input surge protection & and reduce output ripple sufficiently. In this case, capacitors C1 and C3 could be connected as shown in the simple connection above, without the other filter components. Recommended capacitor values are given in the table above.

## Output Voltage Tolerance: 3.3 V<sub>OUT</sub> Models

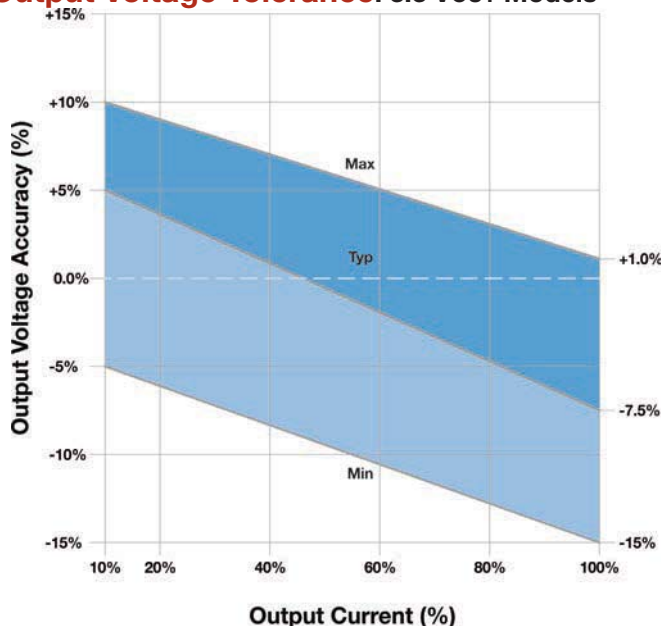

## Output Voltage Tolerance: All Other Models

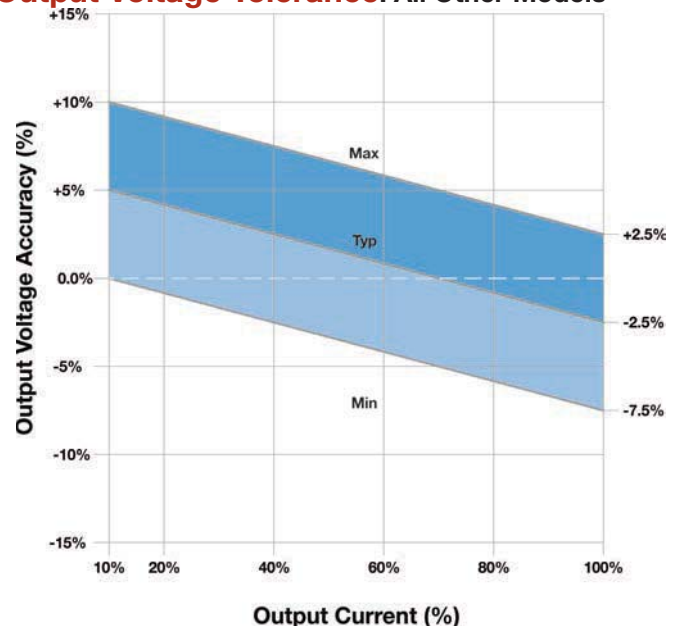

### Efficiency vs Input Voltage (5VIN, Full Load)

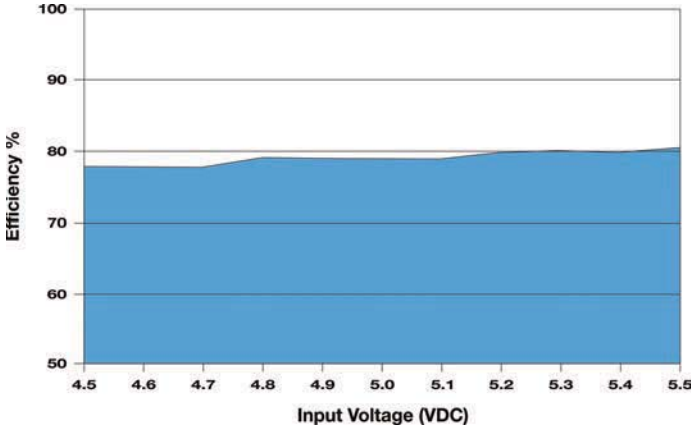

### Efficiency vs Output Power (VIN = 5 VDC)

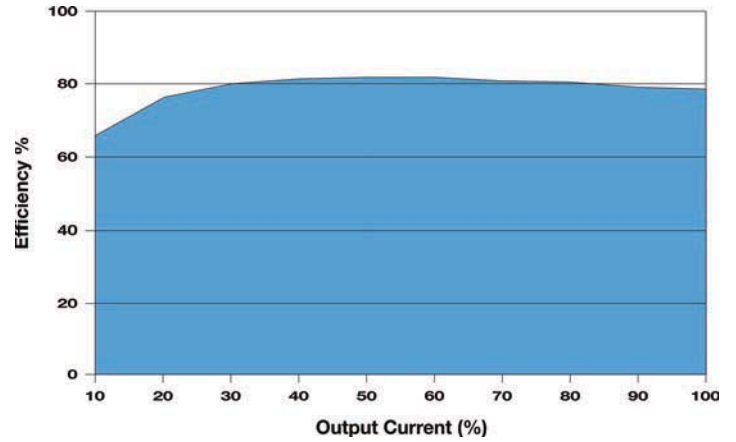

### Efficiency vs Input Voltage (12VIN, Full Load)

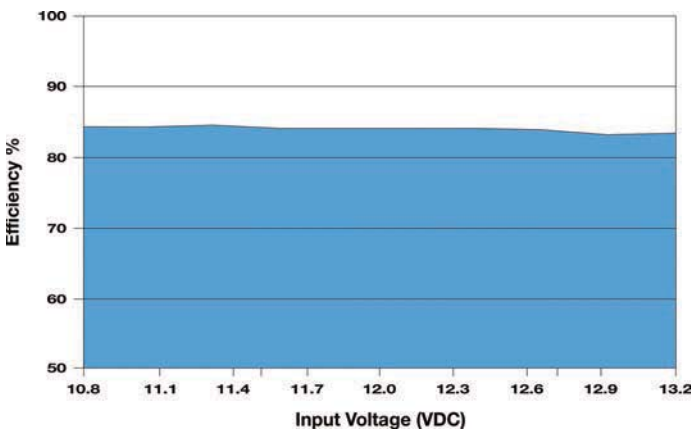

### Efficiency vs Output Power (VIN = 12 VDC)

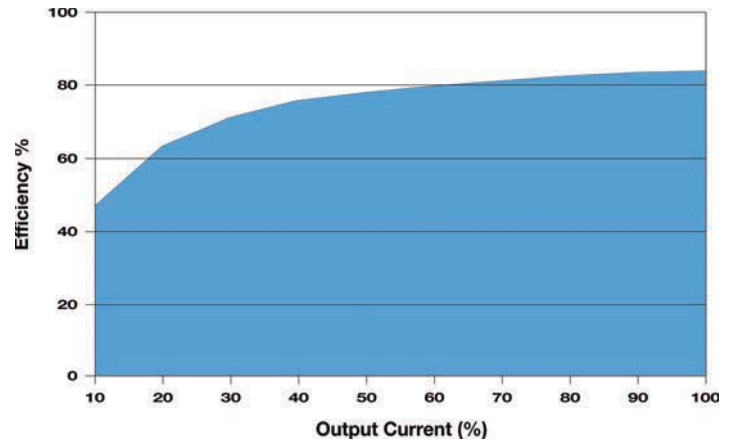

### Mechanical Dimensions

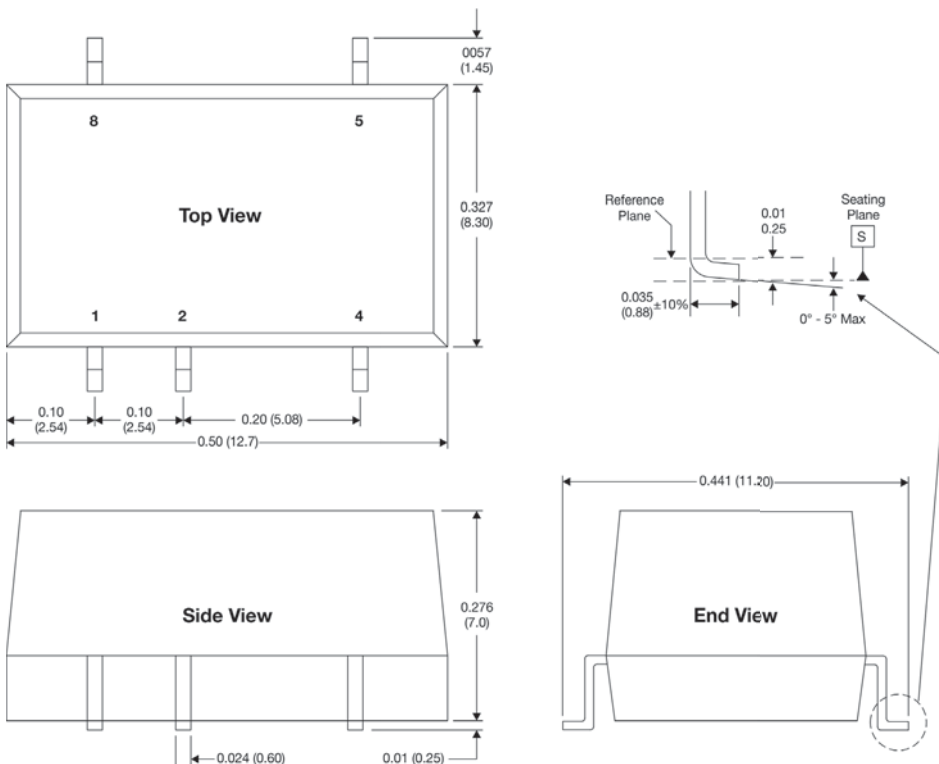

### Pin Connections

| Pin | Description | Pin | Description |
|-----|-------------|-----|-------------|
| 1   | -VIN        | 4   | -VOUT       |
| 2   | +VIN        | 5   | +VOUT       |
|     |             | 8   | NC          |

NC = No Connection

### Solder Pad Layout

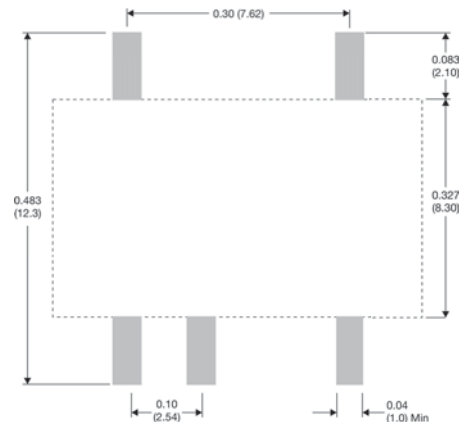

#### Notes:

- All dimensions are typical in inches (mm)
- Tolerance x.xx = ±0.01 (±0.25)
- Pin 1 is marked by a "dot" or indentation on the unit

# Reel Dimensions Reel Capacity = 500 pcs

CompuMess Elektronik GmbH · Lise-Meitner-Straße 4 · D-85716 Unterschleißheim  
 Telefon (089) 321501-0 · Telefax (089) 321501-11  
 info@compumess.de · www.compumess.de · www.netzteile.de

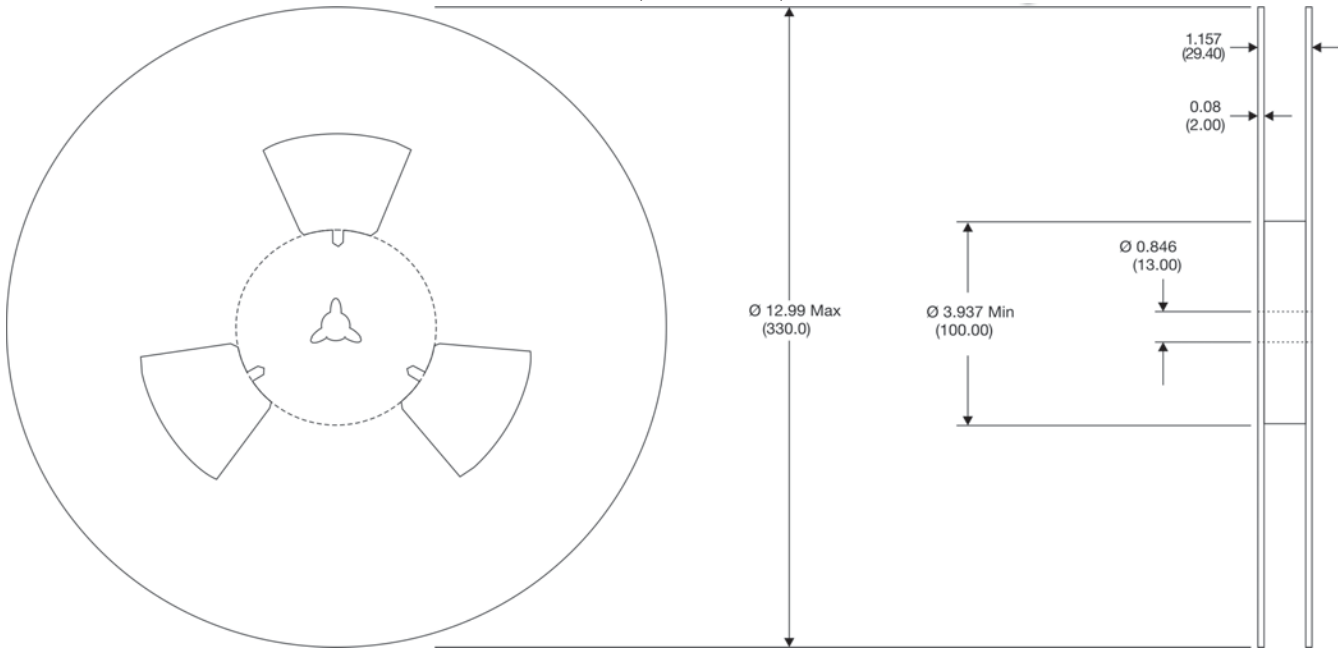

# Tape Dimensions

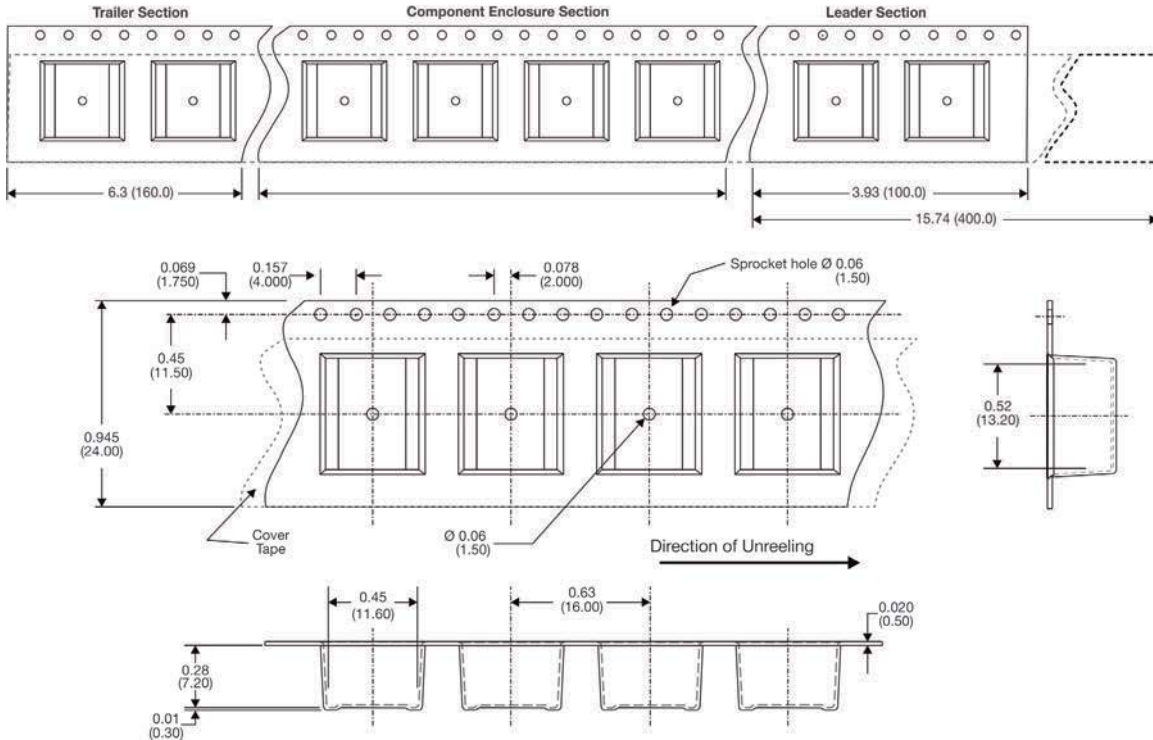

# Tube Dimensions

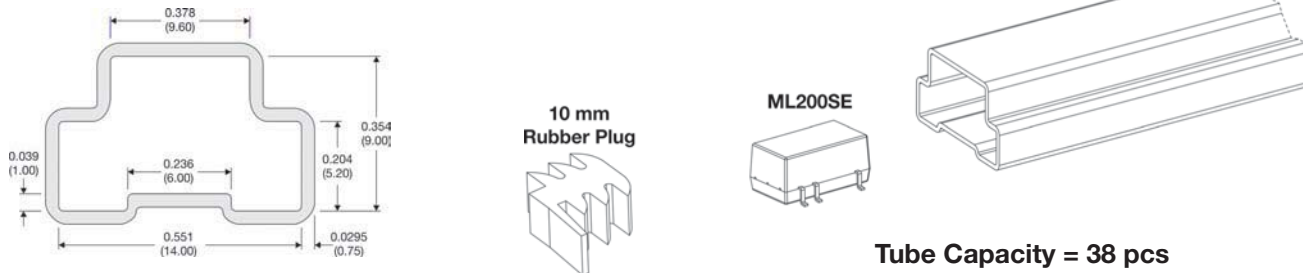

Tube Capacity = 38 pcs



**MicroPower Direct**  
 We Power Your Success - For Less!