

MI2500RU Series

Compact, 1 x 1 Inch 25W, 4:1 Input Range DC/DC Converters



Key Features:

- 25W Output Power
- 4:1 Input Voltage Range
- Compact 1 x 1 Inch Case
- 1,500 VDC Isolation
- 12 Standard Models
- Efficiency to 90%
- Wide Temp Operation
- Industry Standard Pin-Out



MicroPower Direct



Electrical Specifications

Specifications typical @ +25°C, nominal input voltage & rated output current, unless otherwise noted. Specifications subject to change without notice.

Input						
Parameter	Conditions	Min.	Typ.	Max.	Units	
Input Start Voltage	24 VDC Input			9.0	VDC	
	48 VDC Input			18.0		
Input Filter	LC Filter					
Start-Up Time	See Note 2			30	mS	
Output						
Parameter	Conditions	Min.	Typ.	Max.	Units	
Output Voltage Accuracy				±1.0	%	
Output Voltage Balance	Dual Output, Balanced Loads			±2.0	%	
Line Regulation	V _{IN} = Min to Max			±0.2	%	
Load Regulation, Min Load to Full Load	Single Output			±0.2	%	
	Dual Output			±1.0		
Cross Regulation, Dual Outputs	Asymmetrical Load 25%/100%			±5.0	%	
Ripple & Noise, See Note 3	3.3 & 5.0 Vout		100		mV P - P	
	12, 15 & Dual Output		150			
Transient Recovery Time, See Note 4			250		µSec	
Transient Response Deviation	25% Load Step Change		±3.0	±5.0	%	
Temperature Coefficient				±0.02	%/°C	
Output Power Protection	See Note 5		150		%	
Output Short Circuit, See Note 6	Continuous (Autorecovery)					
General						
Parameter	Conditions	Min.	Typ.	Max.	Units	
Isolation Voltage	60 Seconds	1,500			VDC	
	1 Second	1,800				
Isolation Resistance	500 VDC	1,000			MΩ	
Isolation Capacitance	100 kHz, 1V			2,000	pF	
Switching Frequency			285		kHz	
EMI Characteristics						
Parameter	Standard	Criteria	Level			
Conducted Emissions, See Page 3	EN 55032		Class A/B			
ESD	EN 61000-4-2	A	±8 kV Air, ±6 kV Contact			
RS	EN 61000-4-3	A	10 V/m			
EFT, See Page 3	EN 61000-4-4	A	±2 kV			
Surge, See Page 3	EN 61000-4-5	A	±1 kV			
CS	EN 61000-4-6	A	10 V/rms			
Environmental						
Parameter	Conditions	Min.	Typ.	Max.	Units	
Operating Temperature Range	See Page 4	-40	+25	+80	°C	
	Case			+105		
Storage Temperature Range		-50		+125	°C	
Cooling	Free Air Convection					
Humidity	RH, Non-condensing			95	%	
Case Size		See Mechanical Diagrams (Page 7)				
Case Material		Metal with Non-Conductive Base				
Weight	Without Heatsink				0.58 Oz (16.5g)	
	With Heatsink				0.65 Oz (18.5g)	
Reliability Specifications						
Parameter	Conditions	Min.	Typ.	Max.	Units	
MTBF	MIL HDBK 217F, 25°C, Gnd Benign	444			kHours	
Absolute Maximum Ratings						
Parameter	Conditions	Min.	Typ.	Max.	Units	
Input Voltage Surge (100 mS)	24 VDC Input			50.0	VDC	
	48 VDC Input			100.0		
Lead Temperature	1.5 mm From Case For 10 Sec			260.0	°C	

Caution: Exceeding Absolute Maximum Ratings may damage the module. These are not continuous operating ratings.

Model Selection Guide

Model Number	Input				Output			Efficiency (% Typ)	Over Voltage Protection (VDC)	Capacitive Load (µF Max)	Fuse Rating Slow-Blow (mA)
	Voltage (VDC)		Current (mA)		Voltage (VDC)	Current (mA, Max)	Current (mA, Min)				
	Nominal	Range	Full-Load	No-Load							
MI2524S-03RU(-H)	24	9.0 - 36.0	950	85	3.3	6,000	0.0	87	3.9	10,300	5,000
MI2524S-05RU(-H)	24	9.0 - 36.0	1,170	85	5.0	5,000	0.0	89	6.2	6,800	5,000
MI2524S-12RU(-H)	24	9.0 - 36.0	1,175	85	12.0	2,090	0.0	89	15.0	1,200	5,000
MI2524S-15RU(-H)	24	9.0 - 36.0	1,160	85	15.0	1,670	0.0	90	18.0	750	5,000
MI2524D-12RU(-H)	24	9.0 - 36.0	1,170	85	±12.0	±1,040	0.0	89	±15.0	680	5,000
MI2524D-15RU(-H)	24	9.0 - 36.0	1,180	85	±15.0	±840	0.0	89	±18.0	380	5,000
MI2548S-03RU(-H)	48	18.0 - 75.0	470	45	3.3	6,000	0.0	88	3.9	10,300	2,500
MI2548S-05RU(-H)	48	18.0 - 75.0	580	45	5.0	5,000	0.0	90	6.2	6,800	2,500
MI2548S-12RU(-H)	48	18.0 - 75.0	580	45	12.0	2,090	0.0	90	15.0	1,200	2,500
MI2548S-15RU(-H)	48	18.0 - 75.0	580	45	15.0	1,670	0.0	90	18.0	750	2,500
MI2548D-12RU(-H)	48	18.0 - 75.0	585	45	±12.0	±1,040	0.0	89	±15.0	680	2,500
MI2548D-15RU(-H)	48	18.0 - 75.0	590	45	±15.0	±840	0.0	89	±18.0	380	2,500

- Notes:**
- The specified maximum capacitive load is for each output.
 - Start up time is measured at nominal input and with a constant resistive load.
 - When measuring output ripple, it is recommended that an external 1 µF capacitor and 10 µF capacitor be connected in parallel from the +Vout to the -Vout pin for single output units; or from each output to common for dual output units.
 - Transient recovery is measured to within a 1% error band for a load step change of 25%.
 - Over Power protection is provided by a "hiccup mode" current limiting circuit.
 - Short circuit protection is provided by a "hiccup mode" circuit.
 - The output over voltage protection circuit is independent of the primary regulation loop. It provides redundant protection against any possible overvoltage.
 - Operation at no-load will not damage these units.
 - It is recommended that a fuse be used on the input of a power supply for protection. See the Model Selection table above for the correct rating.

For heatsink option, add suffix "H" to model number (i.e. **MI2512S-05RU-H**)

Models are also available at 25W with a 2:1 Input. See the: **MI2512S-05RW** series.

Remote On/Off

All models of the MI25000RU series can be turned on/off remotely by applying a positive logic signal to pin 6. The specifications for the ON/OFF function are given in the table below.

Parameter	Min	Typ	Max	Units
Supply On	3.5		12.0	VDC
Supply Off	0.0		1.2	VDC
Standby Input Current		3.0		mA
Control Common	Referenced to Negative Input (pin 2)			
Control Input Current (ON)			0.5	mA
Control Input Current (OFF)			-0.5	mA

The maximum sink current at the control pin (pin 6) during a logic low is -500 µA. The maximum allowable leakage current of a switch connected to the control pin during a logic high is 10 mA. The switch used can be an open collector transistor, FET or optocoupler. Three possible connections are illustrated in the diagrams below and at right. For more information, please contact the factory.

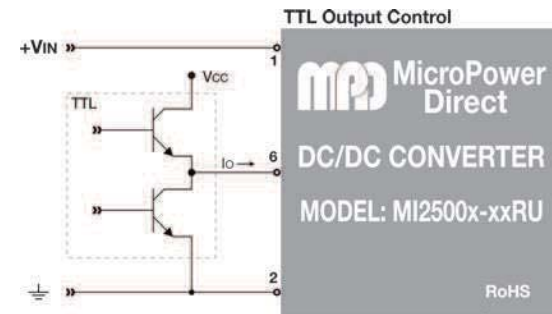
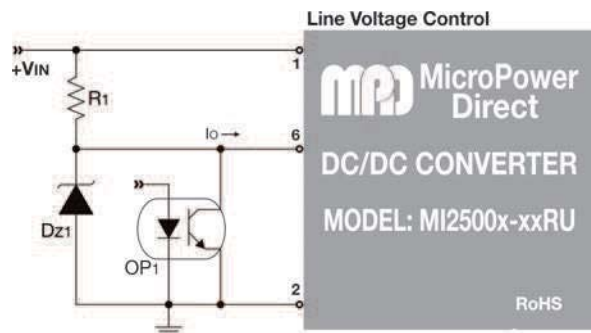
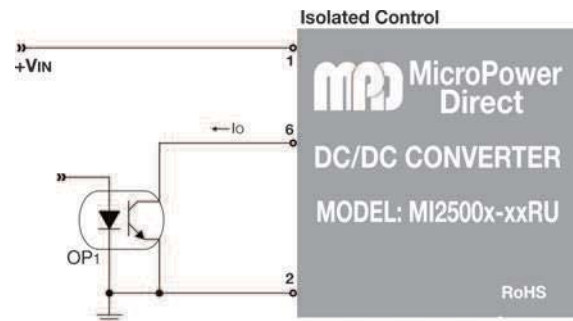

EMC Specifications

All units should meet EN 55032 & EN 55022 class A/B with the simple external circuit shown; using the component values given in the table at right.

Components C₁, C₂ and C₃ are 1210 multilayer ceramic capacitors. C_{Y1} and C_{Y2} are 1206 multilayer ceramic capacitors and C₄ and C₅ are low ESR electrolytic capacitors. The suggested value of the fuse is given in the Model Selection Tables on page 2.

The typical connection diagrams below show the filter configuration for EN 55032 class B operation. The diagram for the single output models also shows the installation of an output trim resistor. For more information on trimming the output voltage, see page 6 of this datasheet. The typical board layout at the bottom of this page includes the connection of an opto-isolator to enable the remote on/off function. For more information on this feature, see page 2 of this datasheet.

To meet the requirements of EN 61000-4-4 and EN 61000-4-5, the value of C₁ should be changed to 220 µF/100V. Contact the factory for more information.

EN 55032 Class A		
Component	MI2524RW	MI2548RW
C ₁	---	---
C ₂	3.3 µF/50V	3.3 µF/100V
L ₁	2.2 µH	4.7 µH
C ₃	---	---
C _{Y1}	---	---
C _{Y2}	---	---
C ₄	4.7 µF	4.7 µF
C ₅	4.7 µF	4.7 µF

EN 55032 Class B		
Component	MI2524RW	MI2548RW
C ₁	3.3 µF/50V	3.3 µF/100V
C ₂	3.3 µF/50V	3.3 µF/100V
L ₁	2.2 µH	4.7 µH
C ₃	3.3 µF/50V	3.3 µF/100V
C _{Y1}	1,800 pF/2kV	1,800 pF/2kV
C _{Y2}	1,800 pF/2kV	1,800 pF/2kV
C ₄	4.7 µF	4.7 µF
C ₅	4.7 µF	4.7 µF

Typical EMC Filter: Single Output Model

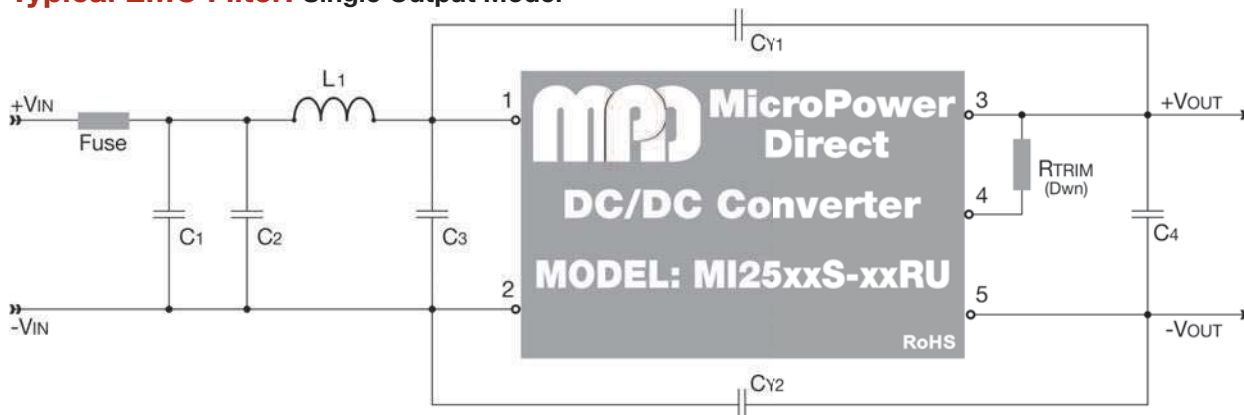

Typical EMC Filter: Dual Output Model

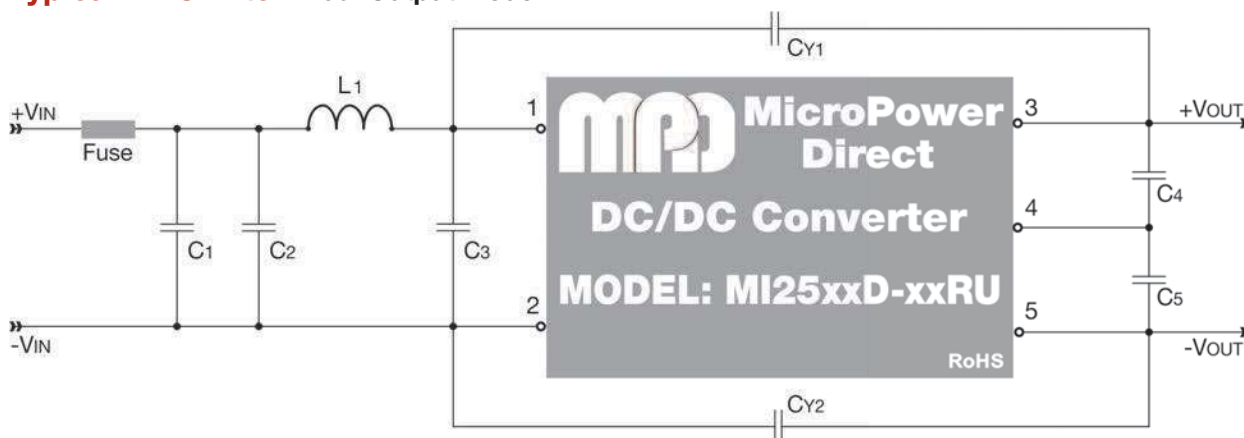

Typical Board Layout: Dual Output Model

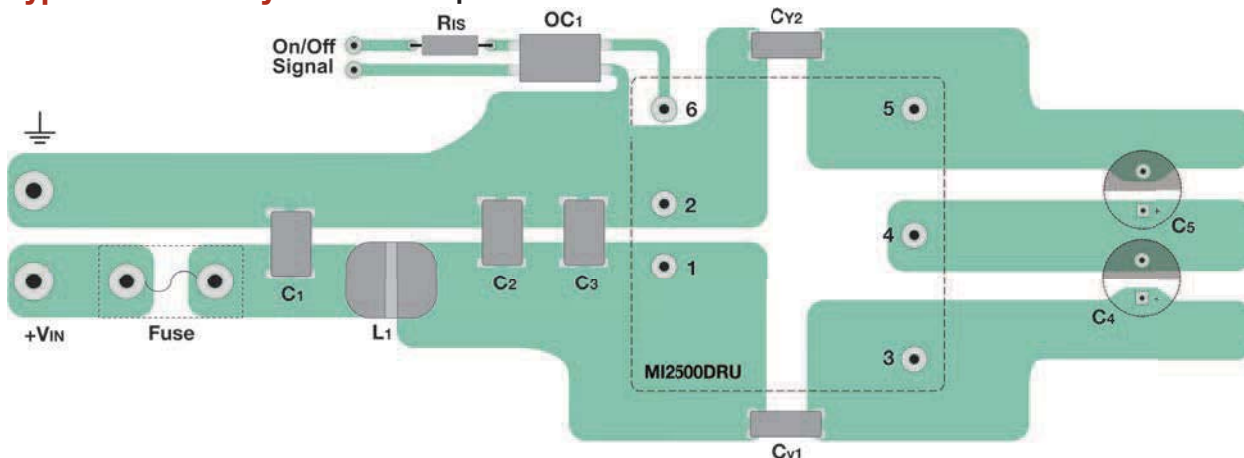

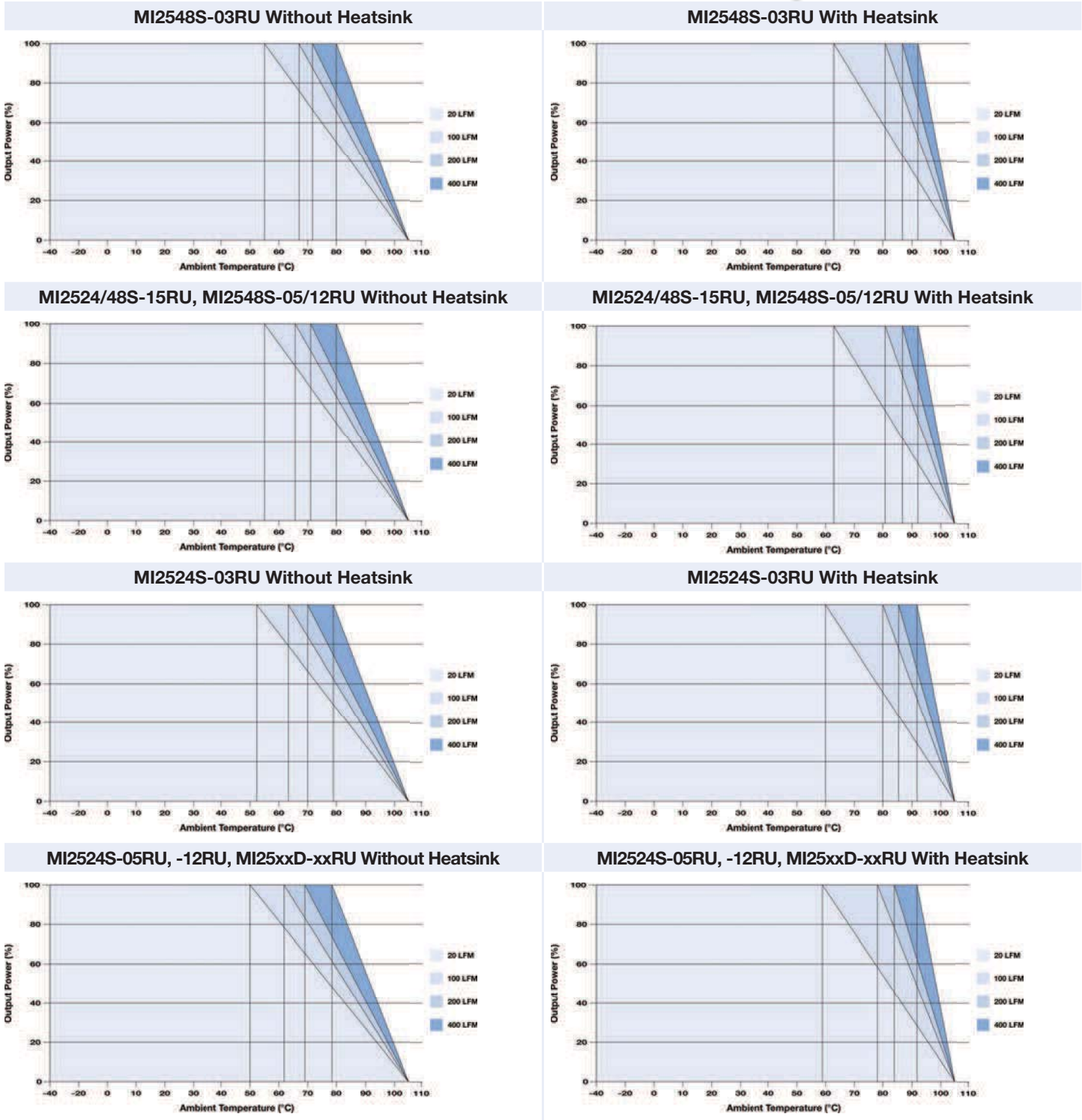

Thermal Impedance

Air Flow	Without Heatsink	With Heatsink	Units
Natural Convection	17.6	14.8	°C/W
100 LFM	13.6	8.5	°C/W
200 LFM	11.8	6.5	°C/W
400 LFM	8.8	4.3	°C/W

Note: Natural Convection equals 20 LFM

Efficiency Vs Output Load Curves

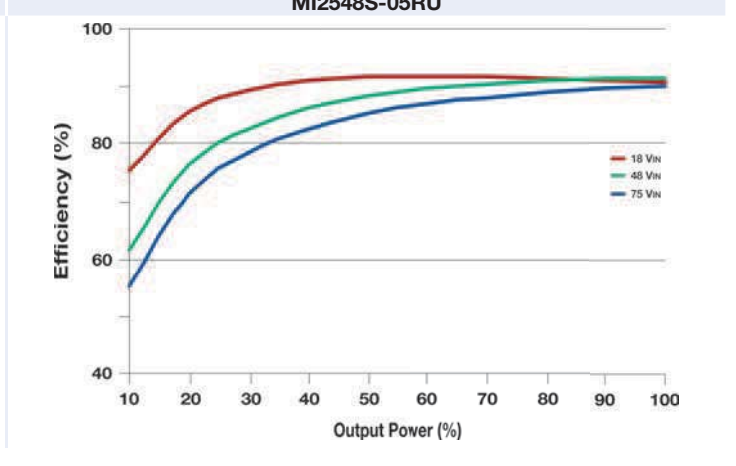
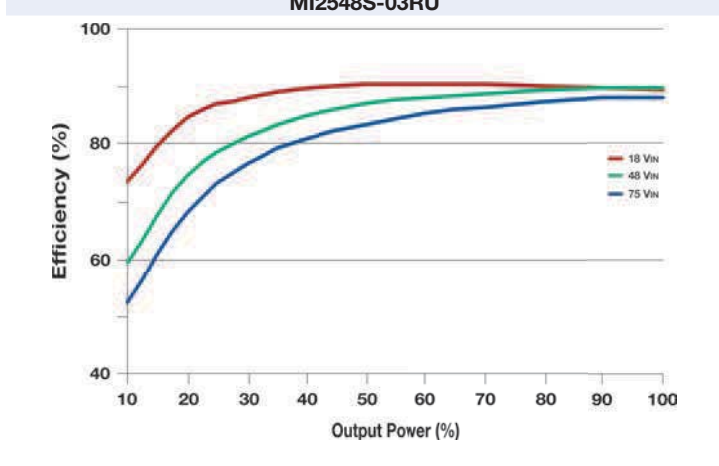
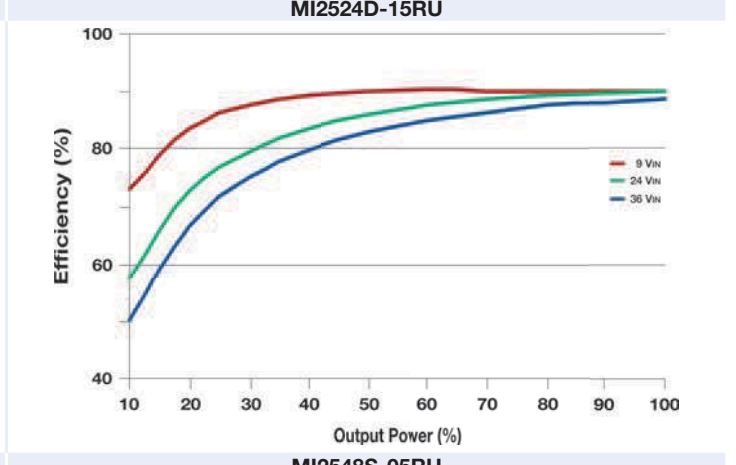
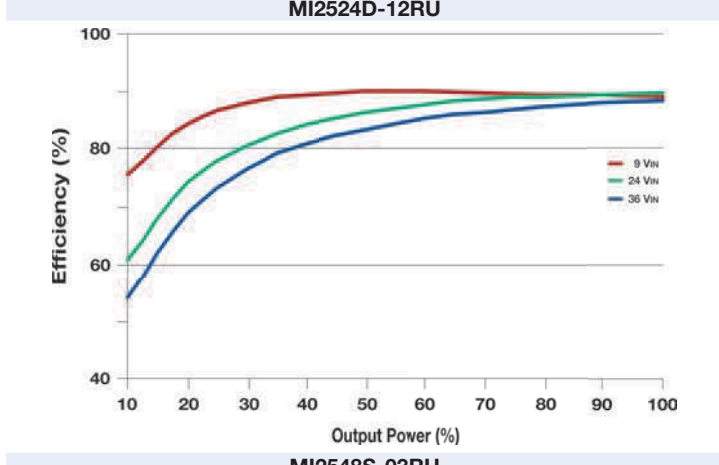
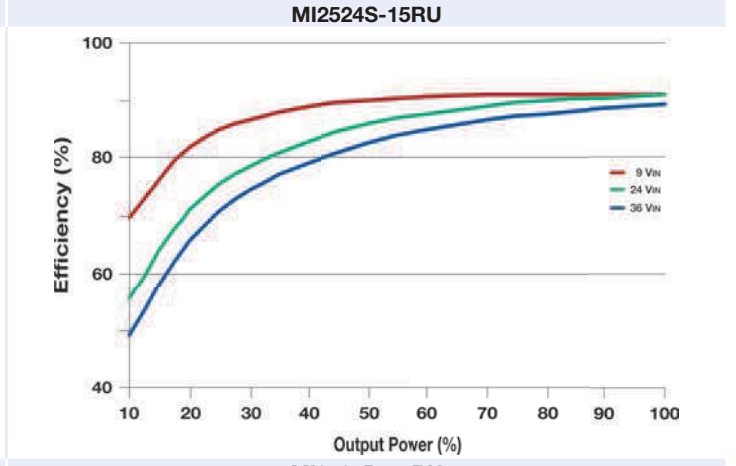
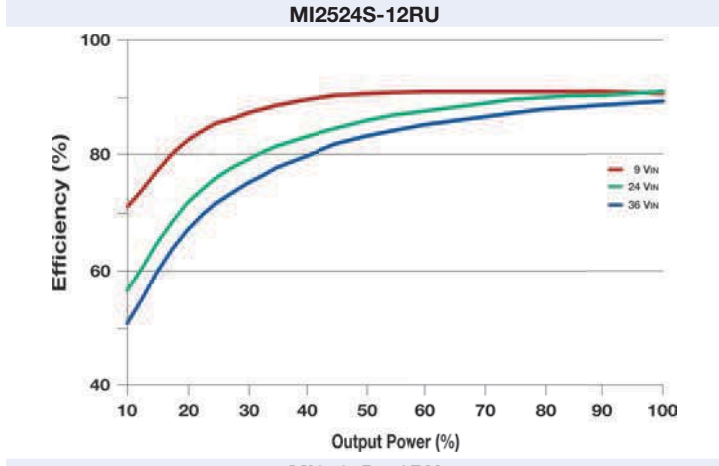
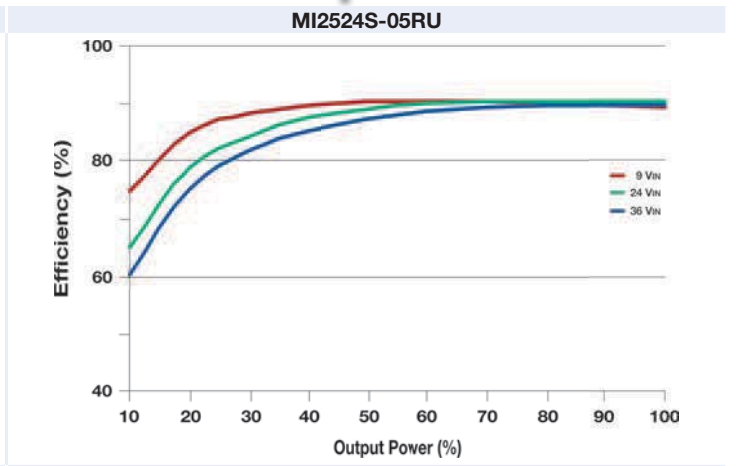
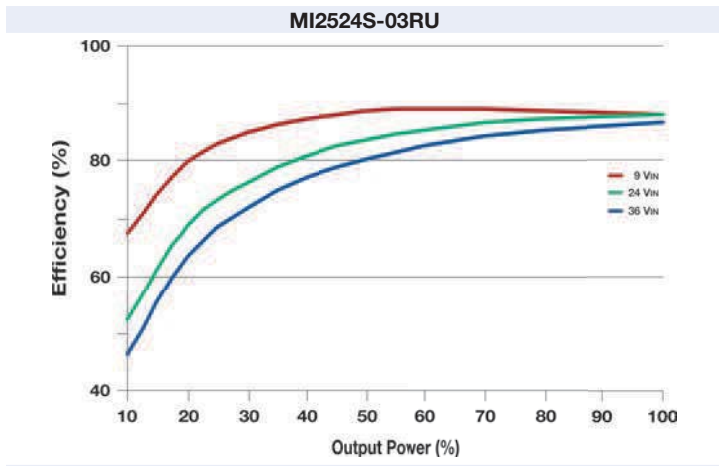

Efficiency Vs Output Load Curves, Continued

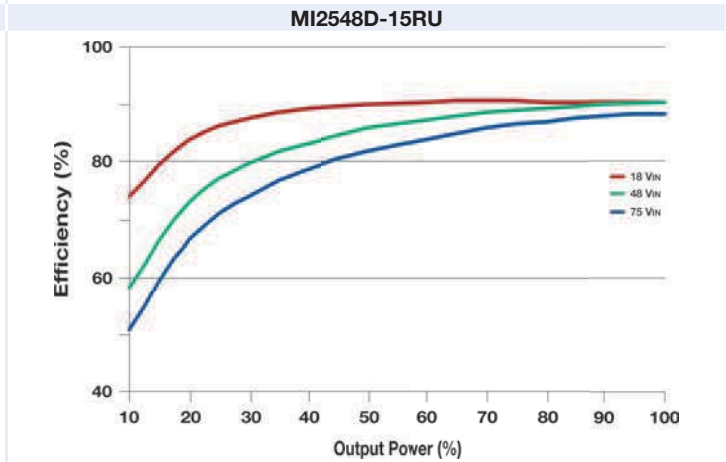
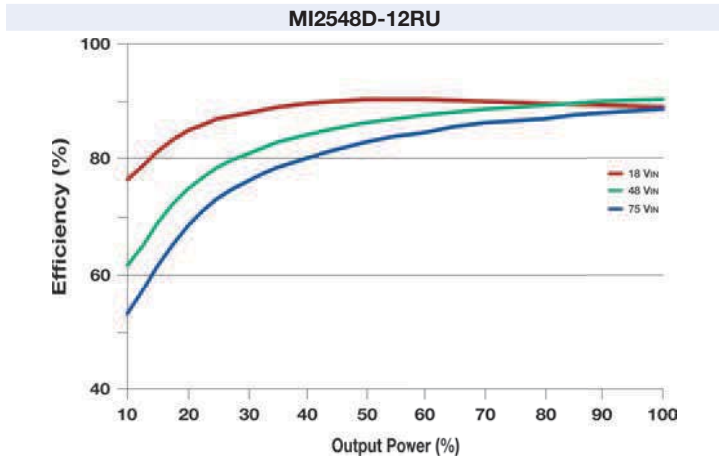
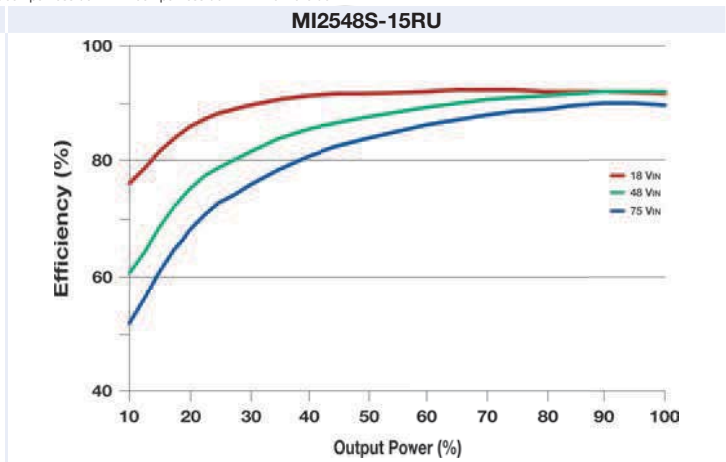
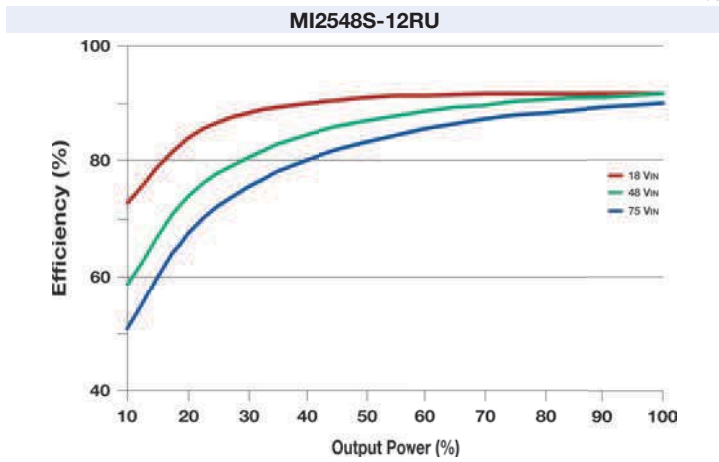

External Trim

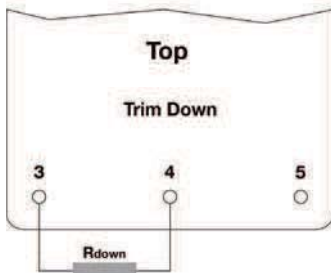
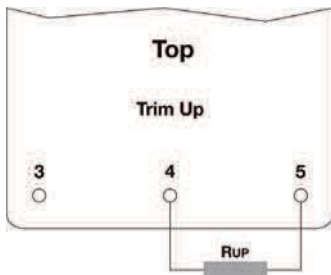

An external resistor may be added to adjust the converter output on single output units.

To adjust the output UP, connect a 5%, 3W resistor between the minus output pin (5) and the Vout trim pin (4). To adjust the output DOWN, connect a 5%, 3W resistor between the plus output pin (3) and the Vout trim pin (4).

The trim table at right gives suggested resistor values for this adjustment.

MI25xxS-03RU

Trim Down											
Vout	Vo x 0.99	Vo x 0.98	Vo x 0.97	Vo x 0.96	Vo x 0.95	Vo x 0.94	Vo x 0.93	Vo x 0.92	Vo x 0.91	Vo x 0.90	Volts
RDOWN	72.61	32.55	19.20	12.52	8.51	5.84	3.94	2.51	1.39	0.50	kΩ

Trim Up											
Vout	Vo x 1.01	Vo x 1.02	Vo x 1.03	Vo x 1.04	Vo x 1.05	Vo x 1.06	Vo x 1.07	Vo x 1.08	Vo x 1.09	Vo x 1.10	Volts
RUP	60.84	27.40	16.25	10.68	7.34	5.11	3.51	2.32	1.39	0.65	kΩ

MI25xxS-05RU

Trim Down											
Vout	Vo x 0.99	Vo x 0.98	Vo x 0.97	Vo x 0.96	Vo x 0.95	Vo x 0.94	Vo x 0.93	Vo x 0.92	Vo x 0.91	Vo x 0.90	Volts
RDOWN	138.88	62.41	36.92	24.18	16.53	11.44	7.79	5.06	2.94	1.24	kΩ

Trim Up											
Vout	Vo x 1.01	Vo x 1.02	Vo x 1.03	Vo x 1.04	Vo x 1.05	Vo x 1.06	Vo x 1.07	Vo x 1.08	Vo x 1.09	Vo x 1.10	Volts
RUP	106.87	47.76	28.06	18.21	12.30	8.36	5.55	3.44	1.79	0.48	kΩ

MI25xxS-12RU

Trim Down											
Vout	Vo x 0.99	Vo x 0.98	Vo x 0.97	Vo x 0.96	Vo x 0.95	Vo x 0.94	Vo x 0.93	Vo x 0.92	Vo x 0.91	Vo x 0.90	Volts
RDOWN	413.55	184.55	108.22	70.05	47.15	31.88	20.98	12.80	6.44	1.35	kΩ

Trim Up											
Vout	Vo x 1.01	Vo x 1.02	Vo x 1.03	Vo x 1.04	Vo x 1.05	Vo x 1.06	Vo x 1.07	Vo x 1.08	Vo x 1.09	Vo x 1.10	Volts
RUP	351.00	157.50	93.00	60.75	41.40	28.50	19.29	12.37	7.00	2.70	kΩ

MB25xxS-15RU

Trim Down											
Vout	Vo x 0.99	Vo x 0.98	Vo x 0.97	Vo x 0.96	Vo x 0.95	Vo x 0.94	Vo x 0.93	Vo x 0.92	Vo x 0.91	Vo x 0.90	Volts
RDOWN	530.73	238.61	141.24	92.56	63.35	43.87	29.96	19.53	11.41	4.92	kΩ

Trim Up											
Vout	Vo x 1.01	Vo x 1.02	Vo x 1.03	Vo x 1.04	Vo x 1.05	Vo x 1.06	Vo x 1.07	Vo x 1.08	Vo x 1.09	Vo x 1.10	Volts
RUP	422.77	189.89	112.26	73.44	50.15	34.63	23.54	15.22	8.75	3.58	kΩ

Mechanical Dimensions

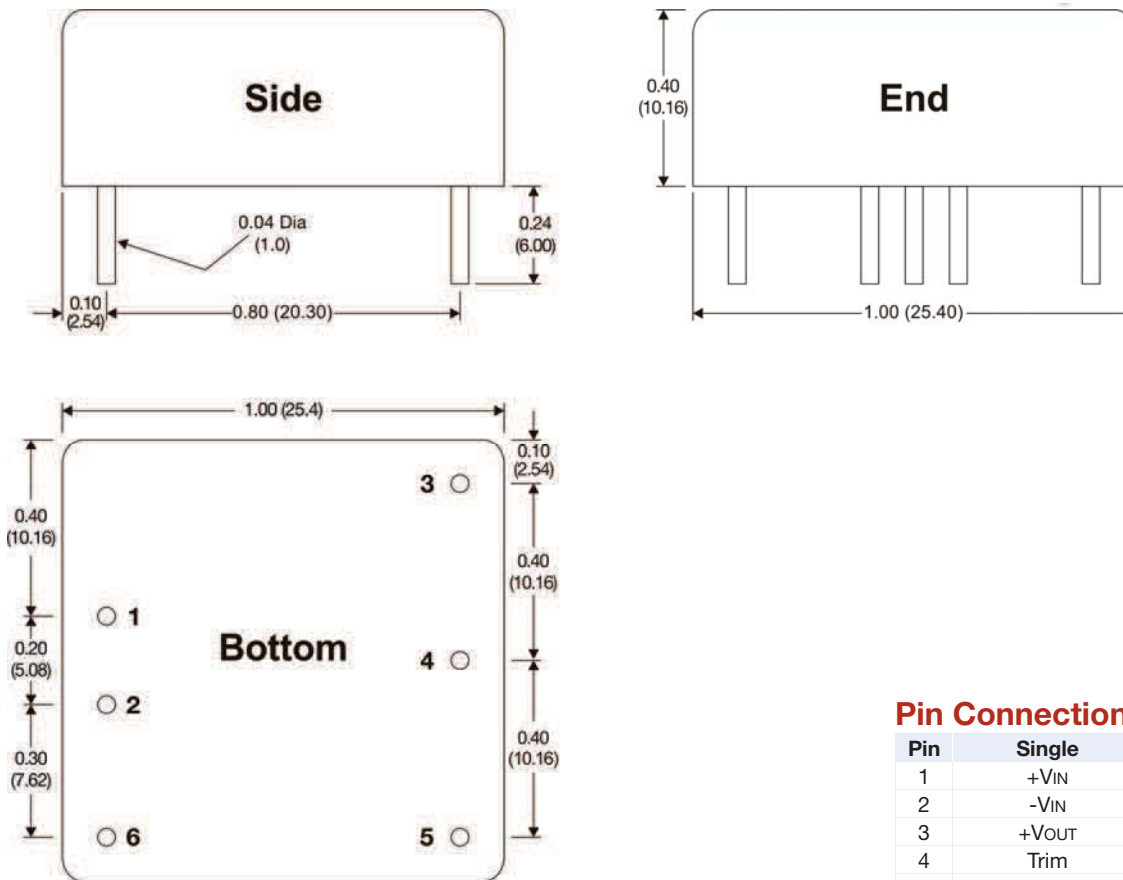

Mechanical Dimensions: With Optional Heatsink

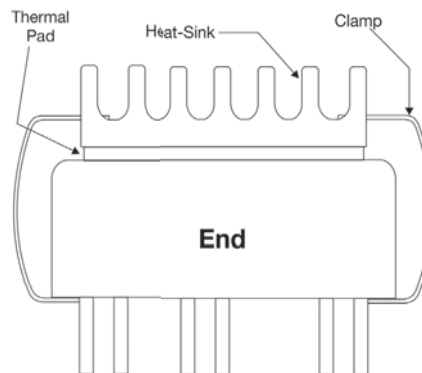
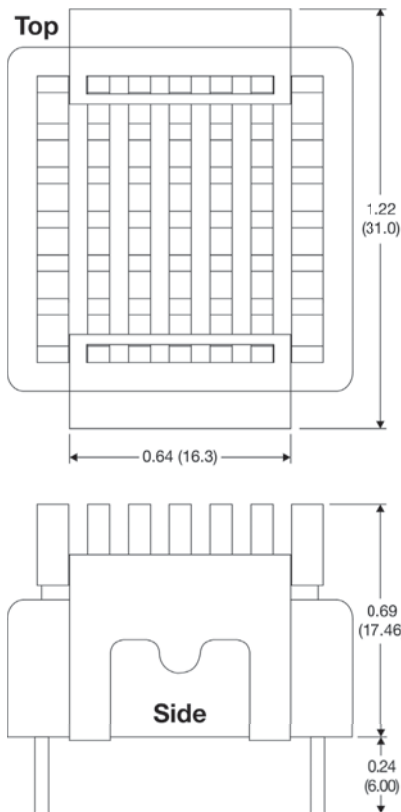

Pin Connections

Pin	Single	Pin	Dual
1	+VIN	1	+VIN
2	-VIN	2	-VIN
3	+VOUT	3	+VOUT
4	Trim	4	Common
5	-VOUT	5	-VOUT
6	Remote On/Off	6	Remote On/Off

For the heatsink option, add suffix "H" to the model number (i.e. **MI2524S-12RU-H**)

Notes:

- All dimensions are typical in inches (mm)
- Tolerance x.xx = ±0.02 (±0.50)
- Heatsink is black, anodized aluminum



MicroPower Direct
 We Power Your Success - For Less!