

# MA600ERU Series



## 4:1 Input, 6W DIP, Single & Dual Output DC/DC Converters

### Key Features:

- 6W Output Power
- 4:1 Input Voltage Range
- 1,500 VDC Isolation
- 17 Standard Models
- Efficiency to 88%
- Compact DIP Case
- -40°C to +85°C Operation
- Industry Standard Pin-Out
- Low Cost

3.0 kV Isolation  
Models  
Available

RoHS



MicroPower Direct



### Electrical Specifications

Specifications typical @ +25°C, nominal input voltage & rated output current, unless otherwise noted. Specifications subject to change without notice.

Input						
Parameter	Conditions	Min.	Typ.	Max.	Units	
Input Voltage Range	24 VDC Input	9.0	24.0	36.0	VDC	
	48 VDC Input	18.0	48.0	75.0		
Input Start Voltage	24 VDC Input			9.0	VDC	
	48 VDC Input			18.0		
Input Filter	π (Pi) Filter					
Output						
Parameter	Conditions	Min.	Typ.	Max.	Units	
Output Voltage Accuracy	I <sub>OUT</sub> = 5% to 100%		±1.0	±2.0	%	
Output Voltage Balance	Dual Outputs, Balanced Loads		±0.5	±1.5	%	
Line Regulation, See Note 1	V <sub>IN</sub> = Min to Max		±0.2	±0.5	%	
Load Regulation	I <sub>OUT</sub> = 5% to 100%		±0.5	±1.0	%	
Cross Regulation	See Note 2			±5.0	%	
Ripple (20 MHz)	See Note 3		10	25	mV P - P	
Noise (20 MHz), See Note 3	3.3, 5 VDC Output		30	80	mV P - P	
	All Other Outputs		50	100		
Transient Recovery Time, See Note 4	25% Load Step Change		300	500	μSec	
Transient Response Deviation			±3.0	±5.0	%	
Temperature Coefficient				±0.03	%/°C	
Output Over Voltage Protection		110		140	%	
Output Short Circuit, See Note 5	Continuous (Autorecovery)					
General						
Parameter	Conditions	Min.	Typ.	Max.	Units	
Isolation Voltage	60 Seconds	1,500			VDC	
Isolation Resistance	500 VDC	1,000			MΩ	
Isolation Capacitance	100 kHz/0.1V		1,000		pF	
Switching Frequency			300		kHz	
EMI Characteristics						
Parameter	Standard		Level			
Radiated Emissions	See Note 6	EN 55022	Class A			
Conducted Emissions	See Note 6	EN 55022	Class A			
ESD		EN 61000-4-2	Criteria B; ±4 kV Contact			
RS		EN 61000-4-3	Criteria A; 10V/m			
EFT	See Note 7	EN 61000-4-4	Criteria B; ±2 kV			
Surge	See Note 8	EN 61000-4-5	Criteria B; ±2 kV			
CS		EN 61000-4-6	Criteria A; 3 Vrms			
Voltage Dips		EN 61000-4-29	Criteria B; 0% - 70%			
Environmental						
Parameter	Conditions	Min.	Typ.	Max.	Units	
Operating Temperature Range	Ambient	-40	+25	+85	°C	
Operating Temperature Range	Case			+105	°C	
Storage Temperature Range		-55		+125	°C	
Cooling	Free Air Convection					
Humidity	RH, Non-condensing			95	%	
Physical						
Case Size	See Mechanical Diagram (Page 4)					
Case Material	Aluminum Alloy					
Weight	0.49 Oz (14g)					
Reliability Specifications						
Parameter	Conditions	Min.	Typ.	Max.	Units	
MTBF	MIL HDBK 217F, 25°C, Gnd Benign	1.0			MHours	
Absolute Maximum Ratings						
Parameter	Conditions	Min.	Typ.	Max.	Units	
Input Voltage Surge (1 Sec)	24 VDC Input	-0.7		50.0	VDC	
	48 VDC Input	-0.7		100.0		
Lead Temperature	1.5 mm From Case for 10 Sec			300	°C	

Caution: Exceeding Absolute Maximum Ratings may damage the module. These are not continuous operating ratings.

# Model Selection Guide

Model Number	Input				Output			Efficiency (% Typ)	Reflected Ripple Current (mA Typ)	Capacitive Load (µF Max)	Fuse Rating Slow-Blow (mA)
	Voltage (VDC)		Current (mA)		Voltage (VDC)	Current (mA, Max)	Current (mA, Min)				
	Nominal	Range	Full-Load	No-Load							
MA624S-03ERU	24	9.0 - 36.0	316	7	3.3	1,500	75	79	20.0	1,800	600
MA624S-05ERU	24	9.0 - 36.0	301	7	5.0	1,200	60	83	20.0	1,000	600
MA624S-12ERU	24	9.0 - 36.0	287	7	12.0	500	25	87	20.0	100	600
MA624S-15ERU	24	9.0 - 36.0	284	7	15.0	400	20	88	20.0	100	600
MA624S-24ERU	24	9.0 - 36.0	287	7	24.0	250	12	87	20.0	47	600
MA624D-05ERU	24	9.0 - 36.0	301	7	±5.0	±600	±30	83	20.0	470	600
MA624D-12ERU	24	9.0 - 36.0	287	7	±12.0	±250	±12	87	20.0	100	600
MA624D-15ERU	24	9.0 - 36.0	287	7	±15.0	±200	±10	87	20.0	100	600
MA624D-24ERU	24	9.0 - 36.0	287	7	±24.0	±125	±6.25	87	20.0	47	600
MA648S-03ERU	48	18.0 - 75.0	156	3	3.3	1,500	75	80	20.0	1,800	300
MA648S-05ERU	48	18.0 - 75.0	148	3	5.0	1,200	60	84	20.0	1,000	300
MA648S-12ERU	48	18.0 - 75.0	144	3	12.0	500	25	87	20.0	100	300
MA648S-15ERU	48	18.0 - 75.0	142	3	15.0	400	20	88	20.0	100	300
MA648S-24ERU	48	18.0 - 75.0	144	3	24.0	250	12	87	20.0	47	300
MA648D-05ERU	48	18.0 - 75.0	150	3	±5.0	±600	±30	83	20.0	470	300
MA648D-12ERU	48	18.0 - 75.0	144	3	±12.0	±250	±12	87	20.0	100	300
MA648D-15ERU	48	18.0 - 75.0	144	3	±15.0	±200	±10	87	20.0	100	300

**Notes:**

1. On dual output models, the line regulation for the -V<sub>OUT</sub> (pin 16) output is ±1.0% max.
2. Cross regulation is measured with the +V<sub>OUT</sub> (pin 14) set to 50% load and the -V<sub>OUT</sub> (pin 16) varied from 10% to 100% load. The load on dual output models should not be unbalanced more than 5%. If the load unbalance is greater than 5%, the unit may not meet all specifications.
3. When measuring output ripple & noise, it is recommended that an external capacitor (1 µF to 10 µF) be placed from the +V<sub>OUT</sub> to the -V<sub>OUT</sub> pins for single output units and from each output to common for dual output models.
4. Transient recovery is measured to within a 1% error band for a load step change of 25%.
5. Short circuit protection is provided by a "hiccup mode" circuit.
6. All units are rated for EN 55022 (CE/RE) class A without external components. They will meet class B with the addition of a discrete filter circuit as shown on page 3. Contact the factory for more information this circuit or one of our filter/surge suppression modules.
7. To meet the requirements of EN 61000-4-4 (±2 kV) external components are needed, as shown on page 3. Contact the factory for more information this circuit or one of our filter/surge suppression modules.
8. To meet the requirements of EN 61000-4-5 (±2 kV), external components are needed. This can be done discretely as shown on page 3. Contact the factory for more information this circuit or one of our filter/surge suppression modules.
9. These units should not be operated with a load under 5% of full load. Operation at no-load will not damage the unit, but they may not meet all specifications.
10. It is recommended that a fuse be used on the input of a power supply for protection. See the Model Selection table above for the correct rating.

## Derating Curve

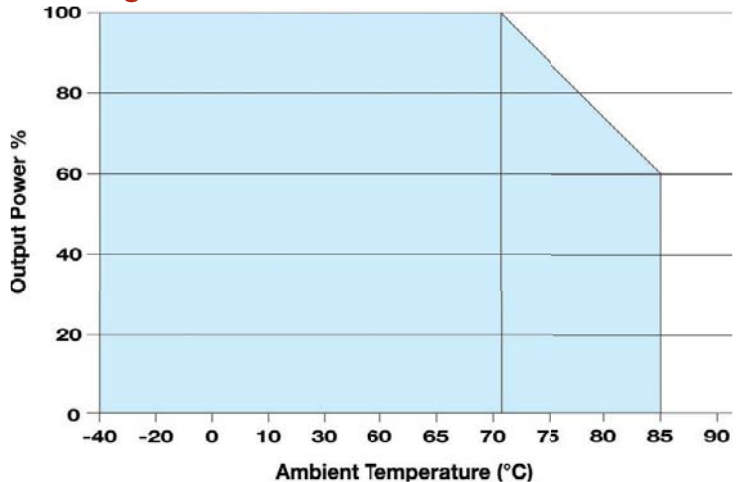

## Efficiency vs Input Voltage: 48 VDC Input

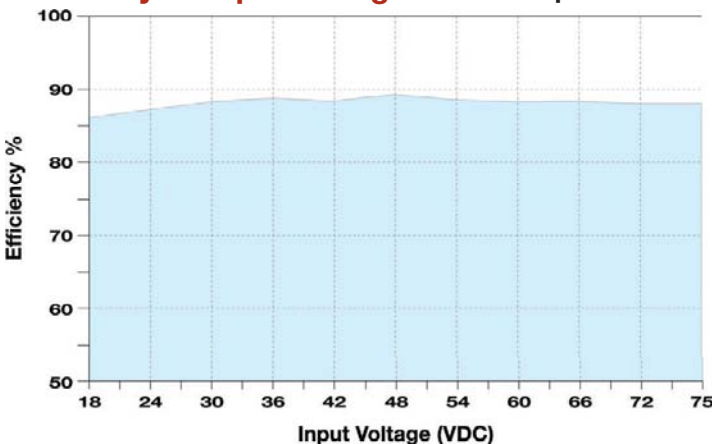

## Efficiency vs Output Load: 48 VDC Input

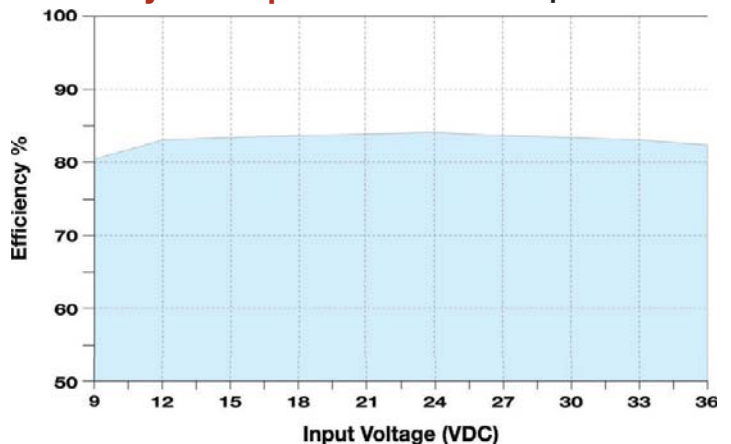

## Typical Connection

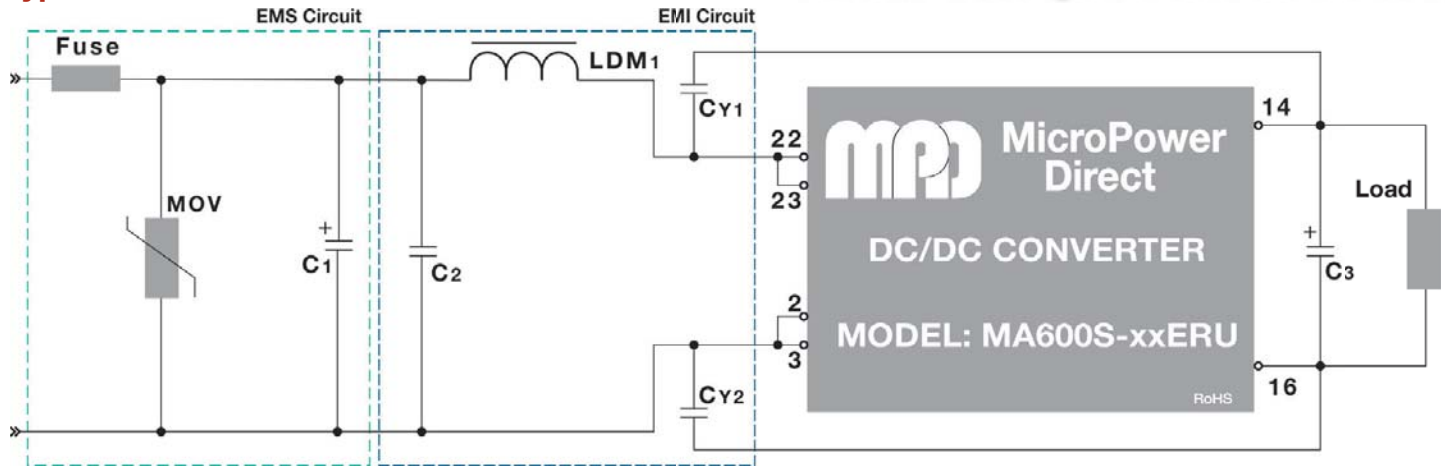

The diagram above illustrates a typical connection of the **MA600ERUI** series for applications that require meeting EMC standards. The units do not require external components to operate as specified. Some notes on this diagram (starting with the input circuit) are:

1. It is recommended that an external fuse be used. The recommended fuse is shown in the model chart on page 2.
2. An external MOV is recommended on the input to protect the unit in the event of a surge. A recommended value is given in the table at right.
3. The output filtering capacitor ( $C_3$ ) is a low ESR electrolytic capacitor. Care must be taken in choosing this capacitor not to exceed the capacitive load specification for the unit. Voltage derating of capacitors should be 80% or above.

5. Recommended values for components are:

Component	24 V <sub>IN</sub>	48 V <sub>IN</sub>
MOV	S14K35	S14K60
C <sub>1</sub>	330 μF/50V	330 μF/100V
C <sub>2</sub>	1.0 μF/50V	1.0 μF/100V
LDM <sub>1</sub>	4.7 μH	4.7 μH
CY <sub>1</sub>	1 nF/2 kV	1 nF/2 kV
CY <sub>2</sub>	1 nF/2 kV	1 nF/2 kV
C <sub>3</sub>	10 μF	10 μF

4. In many applications simply adding input/output capacitors will enhance the input surge protection and reduce output ripple sufficiently. Typically, the value of the input capacitor should be 10 μF to 47 μF. The output capacitor would be 10 μF.

5. Input noise and surge suppression modules are available for a number of **MPD** DC/DC power supplies. For a recommendation for the **MA600xxERU** series, please contact the factory.

## Typical Board Layout: Single Output With External Filter/Surge Components

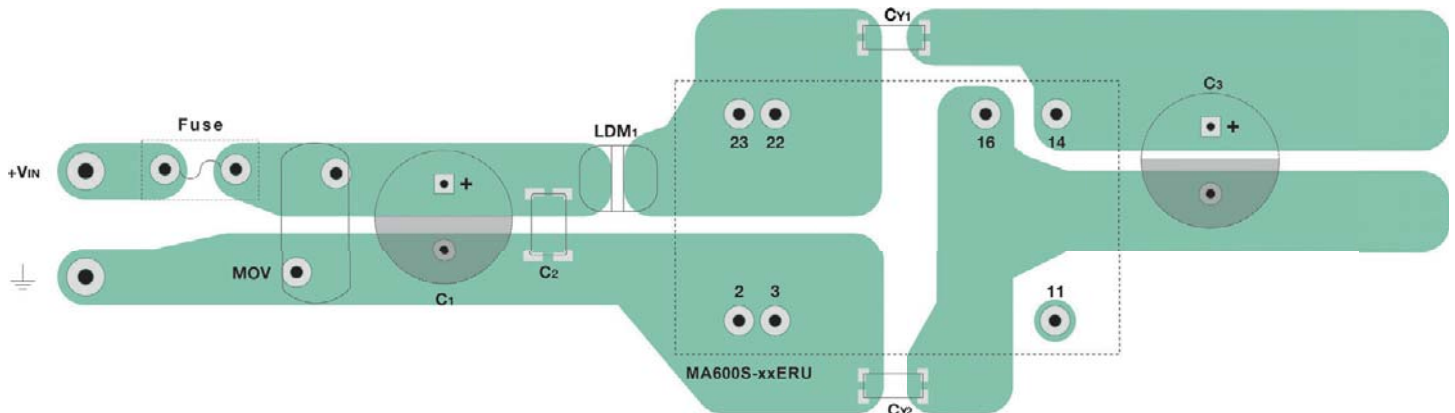

## Typical Board Layout: Dual Output With External Filter/Surge Components

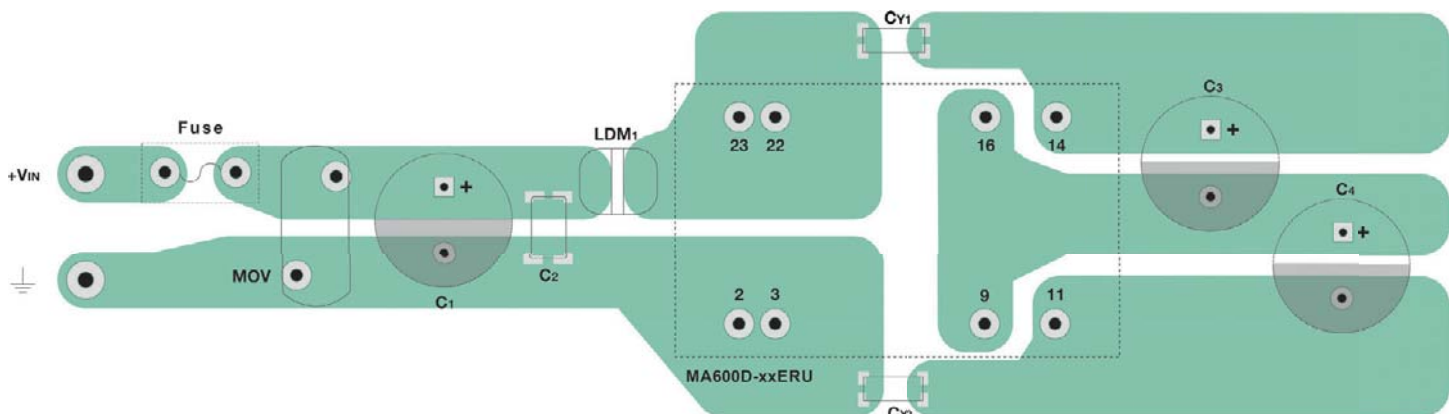

## Mechanical Dimensions

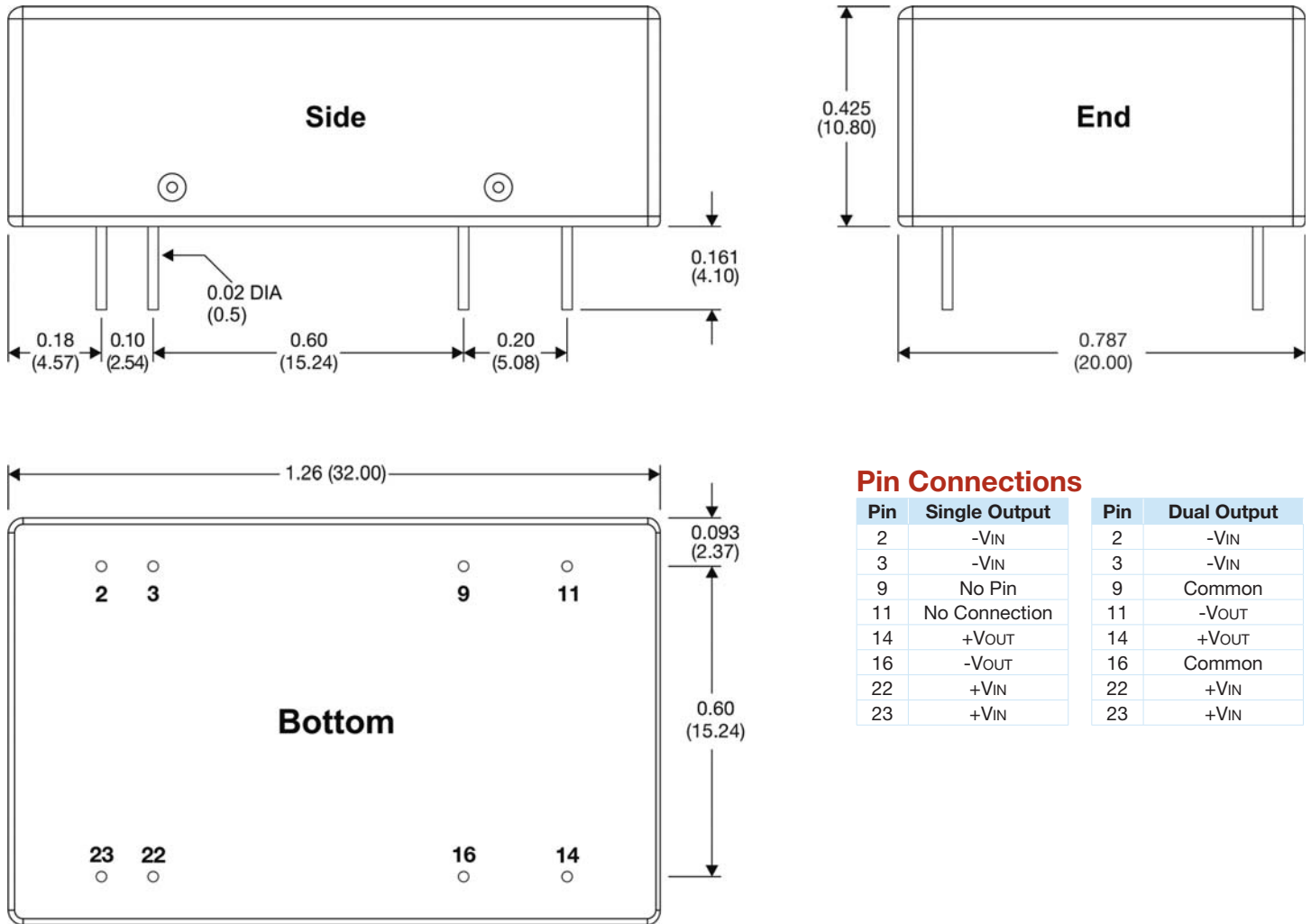

## Pin Connections

Pin	Single Output	Pin	Dual Output
2	-VIN	2	-VIN
3	-VIN	3	-VIN
9	No Pin	9	Common
11	No Connection	11	-VOUT
14	+VOUT	14	+VOUT
16	-VOUT	16	Common
22	+VIN	22	+VIN
23	+VIN	23	+VIN

## Packing Tube Dimensions

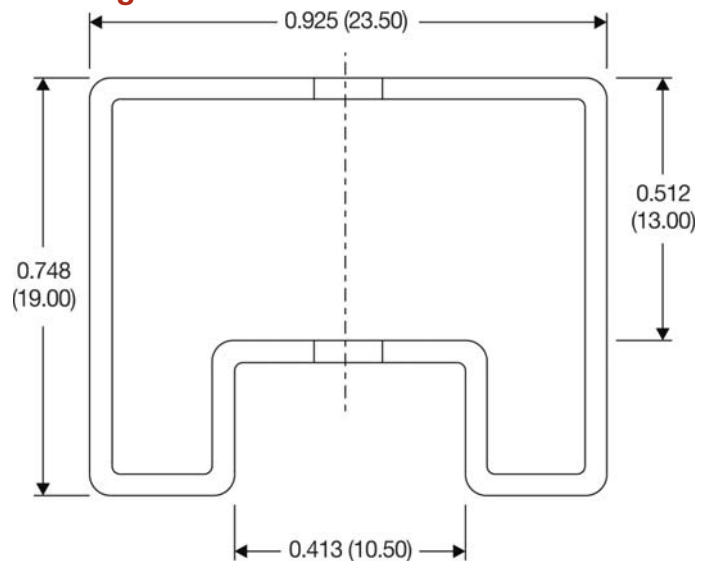

### Notes:

- Tube length equals 20.866 (530), unit quantity equals 15 pcs.
- Tube length equals 8.661 (220), unit quantity equals 6 pcs.
- All dimensions are typical in inches (mm)
- Tolerance x.xx = ±0.02 (±0.50)



**MicroPower Direct**

**We Power Your Success - For Less!**